

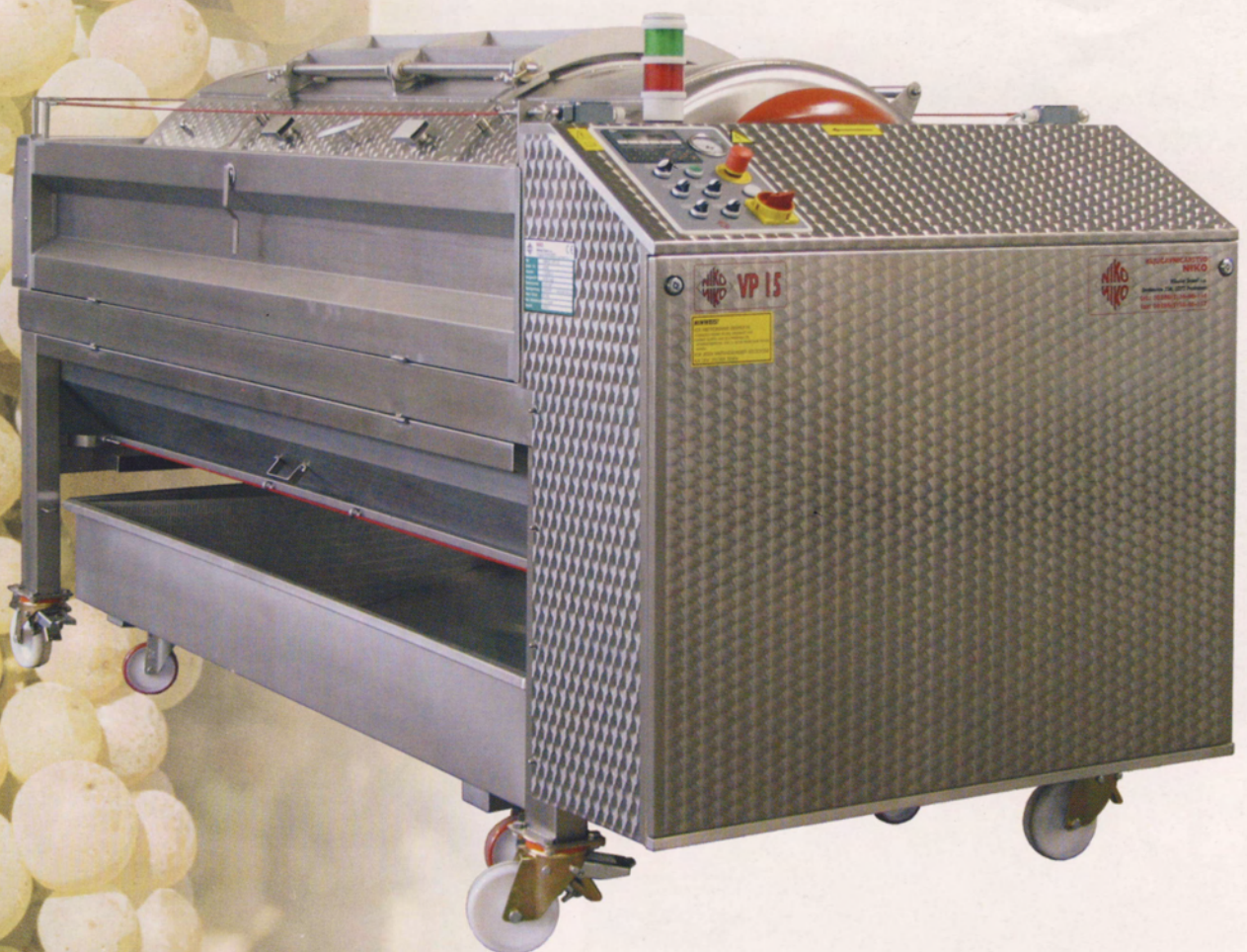

PNEUMATIC PRESS
PNEUMATISCHE PRESSE
PNEVMATSKA STISKALNICA

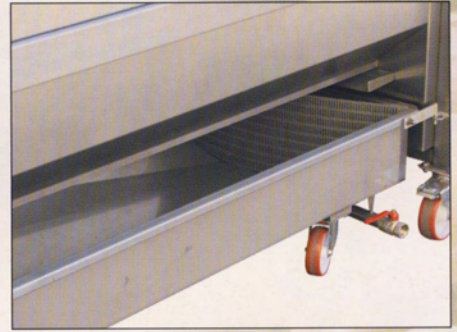

VP11 VP15 VP21 VP26 VP32 VP44

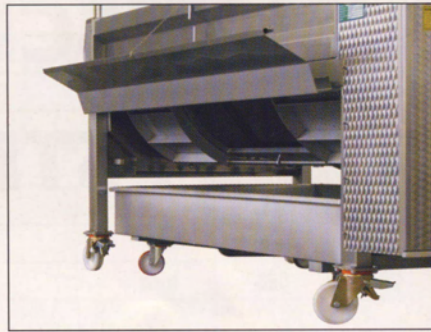
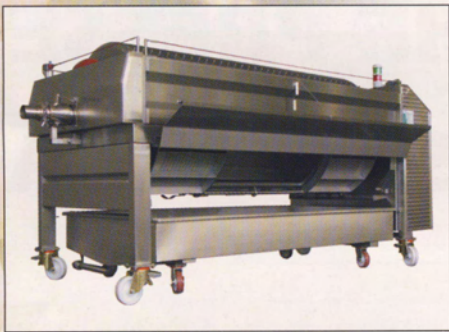

- made of stainless steel
- good sound-absorbing silencer
- fan for fast membrane inflation up to 0.2 bar
- fan for deflation of membrane
- safety cords - movable on sides and fixed at the back
- main supply voltage 400V, three-phase
- big juice collection pan on pivoting wheels with grill filter on the outlet
- upper side panels on hinges - central opening
- lower side panels on hinges - central opening
- framework on pivoting wheels
- membrane made of non-toxic material

- Edeltstahlausführung
- Hochabsorbierender Schalldämper
- Grossvolumigegebläse für schnellen Luftdurchlauf, +0.2 bar
- Grossvolumige Vakuumpumpe
- Sicherheitsseil an Seitenwänden und hinten
- Anschlussspannung 400V dreiphasig
- Grossvolumige Edeltstahlsaftwanne auf Lenkrollen mit Sieb auf dem Ablauf
- Obere Seitenwände in Angeln - zentral Öffnen
- Unter Seitenwände in Angeln - zentral Öffnen
- Gestell auf Lenkrollen mit Bremse
- Membrane aus lebensmittelechten Material

- izvedba iz nerjavečega jekla
- dobro absorbirajoči dušilec zvoka
- ventilator za napihovanje membrane do +0,2 bar
- ventilator za vakuumiranje membrane
- varnostna vrvica na zgornjih stranicah in zadaj
- priključna napetost 400V, trifazna
- veliko korito za sok na vrtljivih kolesih s sitom na iztoku
- zgornje stranice na tečajjih - centralno odpiranje
- spodnje stranice na tečajjih - centralno odpiranje
- vrtljiva kolesa na ogrodju
- membrana iz živilsko neoporečnega materiala

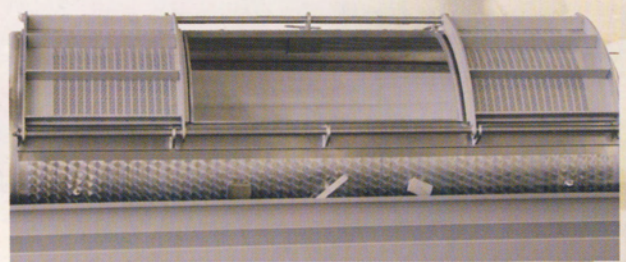
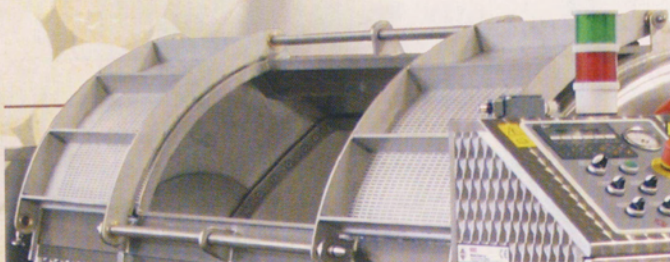

Big sliding door
Fast unloading of the pomace

Grosse Einfüllöffnung
Rasche Entleerung des Trester

Velika drsna vrata
Hitro praznjenje tropin

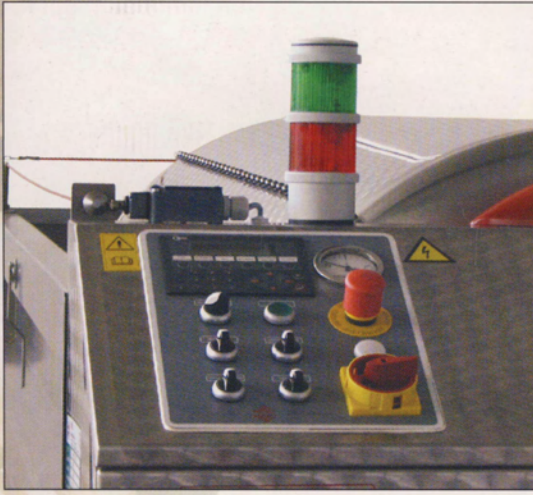

- PLC in a separate box made of stainless steel
- 13 programs: standard programs, cremant programs, programs for ice wine (with unchangeable parameters), program for central loading and a program for maceration.
- space for 20 new programs (standard, cremant or for ice wine) the parameters of which can be changed and saved with different names
- signal lights on the control panel which indicates the state of the press: green light - functioning, flashing red light - error in functioning
- separate manual controls

- PLC im separaten Elektroschaltkasten aus Edelstahl
- 13 Standard-, Cremant- und Icewine- Programme mit fixen Pressparametern

sowie je ein Programm für Zentralbefüllung und Mazerierung

- 20 zusätzliche (Standard-, Cremant- oder Icewine-) Programme mit frei zu bestimmenden Parametern, die unter neuen Namen zu speichern sind
- Ampelleuchte, die über den jeweiligen Zustand der Presse visuell informiert: Grünes Licht signalisiert den Betrieb und blinkendes rotes Licht dagegen eine Betriebsstörung
- Separate Manuellbedienung

- PLC v ločeni omari iz nerjavečega jekla
- 13 programov: standard, cremant, ledeno vino (z nespremenljivo vstavljenimi parametri procesa stiskanja), program za centralno polnjenje in maceracijo
- 20 dodatnih programov (standard, cremant ali ledeno vino), ki se jim po lastni želji določi parametre in jih shrani pod novim imenom
- semaforška signalna svetilka, ki na daljavo sporoča stanje stiskalnice: zelena - delovanje, utripajoča rdeča - motnjo v delovanju
- ločeno ročno upravljanje

Axial loading with manual stainless steel valve
DN65, DN80 or DN100



Zentralfüllung mit manuellem Ventil aus Edelstahl
DN65, DN80 oder DN100

Centralno polnjenje z ročnim ventilom iz nerjavečega jekla
DN65, DN80 ali DN100



Easy and fast cleaning
under the sliding door

Einfach und rasche reinigung unten
Sciebetür

Enostavno in hitro pranje
pod drsnimi vrati

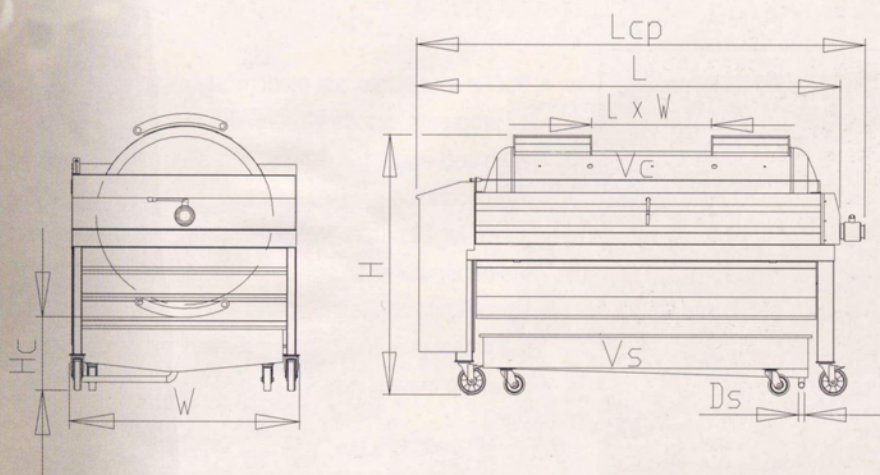

		VP11	VP15	VP21	VP26	VP32	VP44
Vc	lit	1100	1500	2100	2600	3200	4400
L x W	mm	680x440	900x440	760x450	960x450	960x450	960x460
Ds		1"	1 1/4"	1 1/4"	1 1/4"	1 1/2"	1 1/2"
Vs	lit	500	650	730	900	1080	1280
Lcp	mm	2480	2980	2750	3250	3770	3980
L	mm	2310	2810	2580	3080	3580	3790
W	mm	1270	1270	1600	1600	1600	1800
H	mm	1590	1590	1860	1860	1860	2040
Hc	mm	490	490	500	500	580	560
Power supply with integrated compressor Antriebsleistung mit eingeb. Kompressor Priključna moč z vgrajenim kompresorjem	kW	3	4	5.6	6	7	8.5
Dry weight Leergewicht Masa prazne stiskalnice	kg	430	590	790	980	1150	1630

		VP11	VP15	VP21	VP26	VP32	VP44
Whole grapes - loading through the door Ganze Trauben - Trommeltür Celo grozdje - polnjenje skozi vrata	kg	880	1200	1680	2080	2560	3520
Fresh destemmed grapes - axial loading Frischmaische - Zentralbefüllung Sveža drozga - centralno polnjenje	kg	3080	4200	5880	7280	8960	12320
Fermented grapes - axial loading Vergorene Maische - Zentralbefüllung Fermentirana drozga - centralno polnjenje	kg	4180	5700	7980	9880	12160	16720

Technical data is informative. We reserve the right to make changes.
 Technische Angaben unverbindlich, Änderungen vorbehalten.
 Tehnični podatki so informativni. Pridržujemo si pravico do sprememb.



Nikolaj Šraml s.p.
 Podnanos 66a
 SI-5272 Podnanos,
 SLOVENIJA
 tel.: 00386 5 368 6116
 fax: 00386 5 368 6117
 www.niko-si.si
 e-mail: sraml.niko@siol.net